



500 lb. Capacity Game Cart

Instructions for Part# GAME-CART-V2



GENERAL GUIDELINES & SAFETY

- It is the user's responsibility to read and follow all instructions.
- Keep these instructions with the product at all times and review before each use.
- It is the responsibility of this product's owner to furnish the instructions to any person that borrows or purchases the product.
- Inspect the product before use to ensure it is assembled properly and all parts are in safe working order and free of defects.
- Never modify this product in any way.
- All circumstances cannot be addressed in these instructions.
- Please use common sense and practice general safety measures when using this product.
- Parts and/or instructions are subject to change without notice.
- Use good judgment and practice general hunting safety measures and precautions.
- Keep others informed. Hunt with others or let someone know where you will be hunting and when you will return. Carry a cell phone or two-way communication equipment in case of emergency.
- Only use the game cart for its intended purpose.
- Use at least two people to load your game or equipment onto the cart.
- Keep your extremities away from the wheels to prevent injury.
- When transporting cargo, be careful to avoid slippery areas, rocks, steep slopes, logs, stumps, etc. to prevent damage to the cart or cargo and avoid personal injury.
- The weight capacity of this cart is 500 lbs.

PARTS

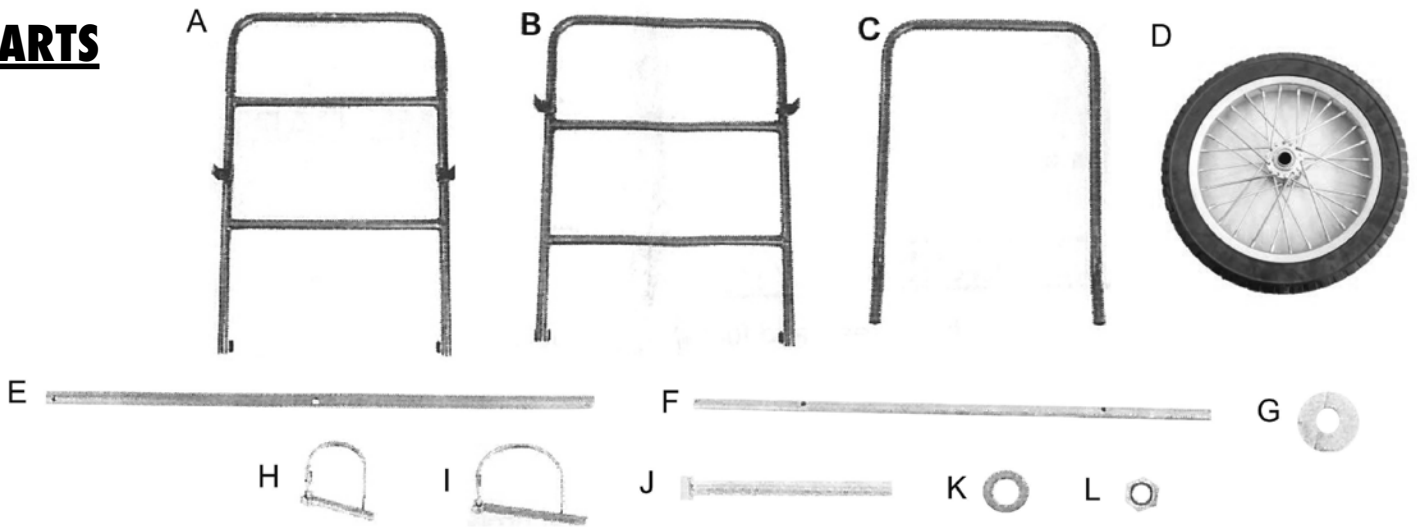

Part	Description	Quantity
A	Top Frame	1
B	Bottom Frame	1
C	Handle	1
D	Wheel	2
E	Support Arm	2
F	Axle	1

Part	Description	Quantity
G	Axle Washer	4
H	Small Spring Pin	4
I	Large Spring Pin	6
J	6 mm Bolt	2
K	Washer	2
L	6 mm Nut	2

ASSEMBLY

Step 1. Align the top frame (A) and bottom frame (B). Insert the axle (F) through the brackets to connect the two pieces.

Fig. 1a

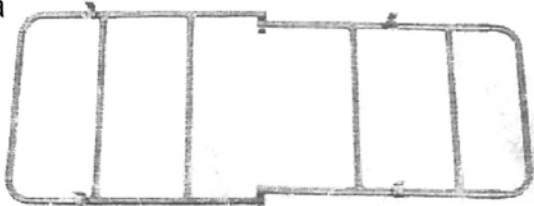
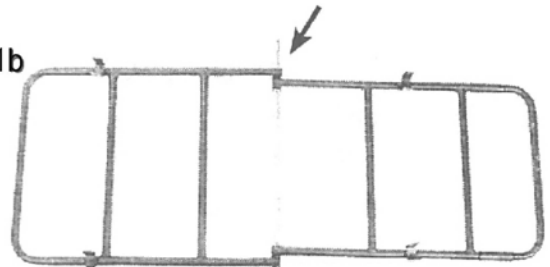

Fig. 1b



Step 2. Connect the support arms (E) to the frame. Place the support arm into the brackets on the bottom frame (B) and top frame (A). Secure in place with large spring pins (I). Repeat for the other support arm.

Fig. 2a

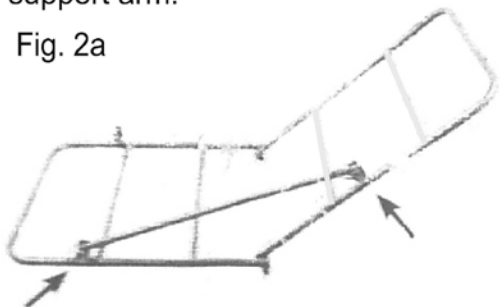

Fig. 2b

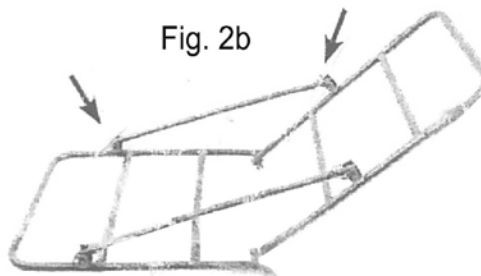
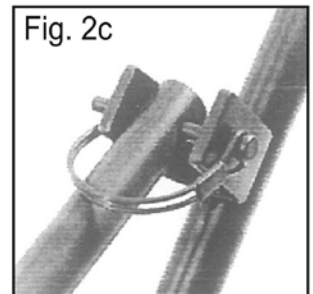
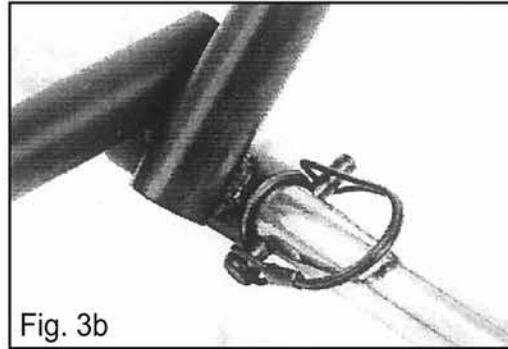
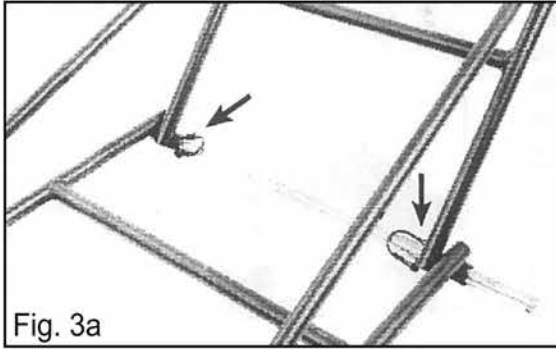

Fig. 2c



Step 3. Secure the axle (F) in place using two small spring pins (H). Insert each pin into the holes on the axle on the inside of the frame.



Step 4. Connect the wheels (D) to the axle (F). Place a washer (G) on the axle. Then, place the wheel onto the axle. Place a second washer (G) onto the axle, then secure in place using a small spring pin (H).

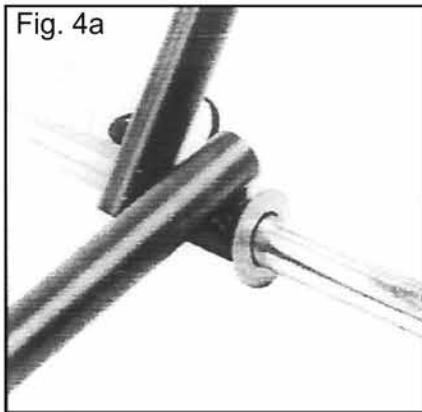

Step 5. Attach the handle (C) to the top frame (A) using the 10mm bolts (J), washers (K), and nuts (L) and two large spring pins (I).

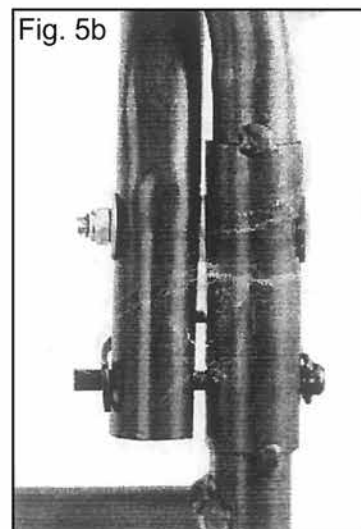
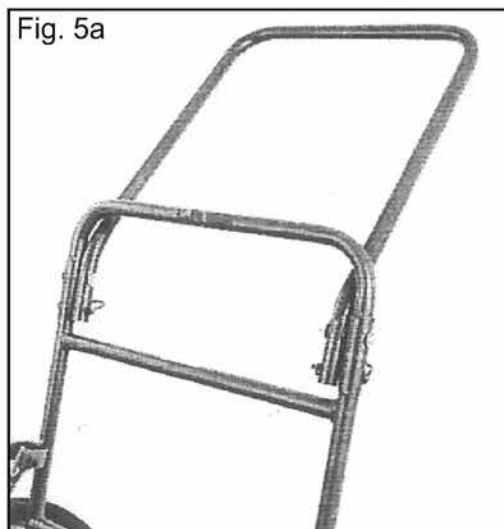

Folding Up the Cart

Step 1. Remove the large spring pins from the support arms. Reattach each support arm to the brackets on the upper frame using the center hole on the support arm and securing with a spring pin. Attach the remaining two spring pins to the brackets on the lower frame.

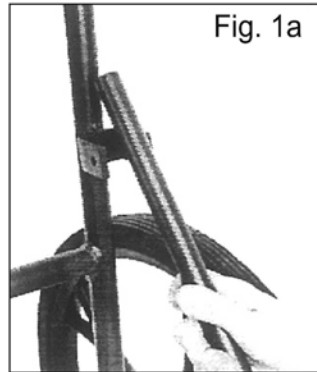

Fig. 1a

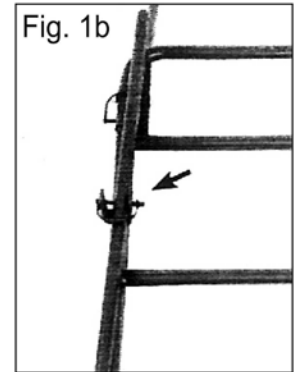

Fig. 1b

Step 2. Remove the small spring pin and washers from each axle end. Remove the wheels. Place the removed washers and spring pin back on the axle and secure.

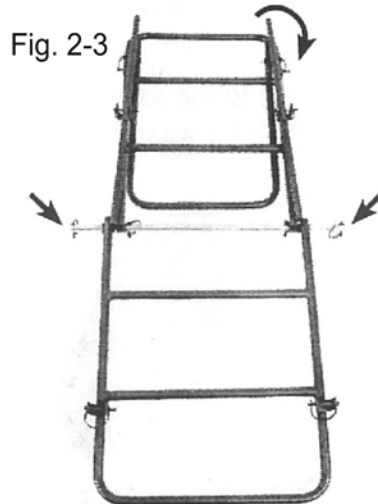

Fig. 2-3

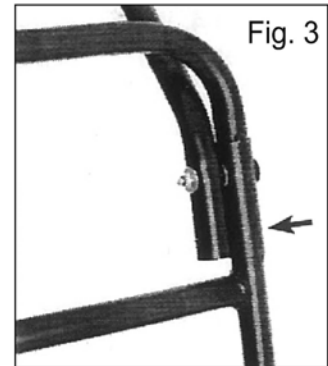

Fig. 3

Step 3. Remove the spring pins from the handle and fold the handle down. Replace the pins into the holes on the top frame only.

Step 4. Fold the upper and lower frame assemblies together, in the reverse direction of the open position. The handle will now be between the upper and lower frame assemblies. The cart will be compact.

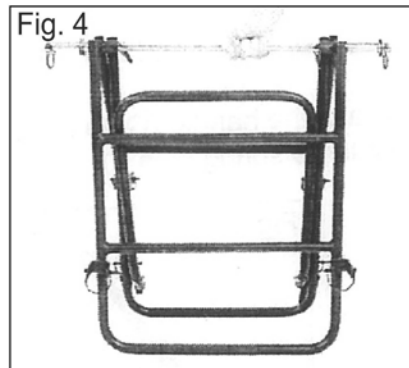

Fig. 4

Step 5. Lay the cart flat on the ground. Attach one wheel to one side of the folded cart using the provided buckle straps. To assure the cart will stay in the folded position, run each buckle strap through both frames and the wheel. Flip the cart over and secure the other wheel in the same manner. Pick up the cart and make sure the straps keep the cart from shifting out of the folding position. Your cart is now ready for transport.



Fig. 5

PRODUCT WARRANTY & LIABILITY

GENERAL PRODUCT WARRANTY: Products purchased from the Authorized Dealer (original place of purchase) or Merchant ("Dealer") will be free of defects in material and workmanship at the time of receipt, and will meet the specifications stated at the place of purchase transaction or online at the Dealer's website, under normal use and service when correctly installed, operated and maintained. This product warranty is effective for the period of time stated below, unless otherwise stated in the product instructions or depicted in the product advertisement. All Authorized Dealer warranties are NON-TRANSFERABLE and cover only the original end purchaser. This limited warranty does not cover products purchased through non-authorized dealers. Non-authorized dealer receipts are not accepted for warranty verification.

*****WARRANTY CLAIMS MUST BE MADE DIRECTLY TO THE ORIGINAL PLACE OF PURCHASE.*****

WARRANTY PERIOD: This warranty remains in force for one year from the date of the product's accepted delivery. The Authorized Dealer offers a one year manufacturer's warranty for most products unless otherwise specified on the product advertisement.

WARRANTY SERVICE: The Authorized Dealer will replace any defective or malfunctioning part at no charge, including payment of the shipping costs of parts or replacement product to and from the manufacturer. The purchaser is responsible for labor charges. If the product does not meet specifications as depicted in the advertisement, the Authorized Dealer will refund the full purchase price of the product.

Questions regarding the warranty on a specific product and warranty claims should be directed to the Authorized Dealer with whom the purchase transaction was made.

WARRANTY LIMITATIONS: The above warranty does not apply to products that are repaired, modified or altered by any party other than the Authorized Dealer; are subjected to unusual physical stress or conditions (such as overloaded ramps or corrosion), natural disaster, governmental actions, wars, strikes, labor disputes, riots, theft, vandalism, terrorism or any reason beyond reasonable control; are damaged due to improper installation, misuse, abuse, accident or negligence in use, storage, transportation or handling, or tampering; or to products that are considered consumable items or items requiring repair or replacement due to normal wear and tear.

Product should be inspected prior to signing for delivery. Product damage incurred during shipping, unless noted on the Bill of Lading at the time of delivery, renders this warranty void.

LIMITED LIABILITY: In no event shall **THE AUTHORIZED DEALER** be liable to the purchaser or any third party for any indirect, incidental, consequential, special, exemplary or punitive damages arising out of the use of the product, including, without limitation, property damage, loss of value of the product or any third party products that are used in or with the product, or loss of use of the product or any third party products that are used in or with the product.

