



Scooter Carrier Swing Away Arm Instructions for Part # SC-SWING-AWAY-V2

General Guidelines

- It is the user's responsibility to read and follow all instructions.
- Keep these instructions with the product at all times and review before each use.
- It is the responsibility of this product's owner to furnish the instructions to any person that borrows or purchases the product.
- Inspect the product before use to ensure it is assembled properly and all parts are in safe working order and free of defects.
- Never modify this product in any way.
- All circumstances cannot be addressed in these instructions. Please use common sense and practice general safety measures when using this product.
- Parts and/or instructions are subject to change without notice.

Safety

- Follow all warnings and instructions marked on the product.
- Be sure to have a proper 2" hitch installed on the vehicle. Do not use with a 1-1/4" hitch or hitch adapters.
- Never exceed vehicle tongue weight rating. The tongue weight includes the total weight of the Swing Away, all accessories, the mobility carrier, and the scooter or power chair.
- The Swing Away is intended for swinging away an empty mobility carrier to provide access to the vehicle rear. Do not operate the Swing Away unit with a scooter or power chair loaded on the carrier.
- Improper use, storage, or installation could result in death or serious injury.
- Do not exceed the 500 lb weight capacity.
- Periodically check the Swing Away for proper functionality and check the nuts and bolts for tightness. Check for any rust, cracks, or flaws that could affect the performance.
- Be sure the latch surface areas are properly greased.



Parts

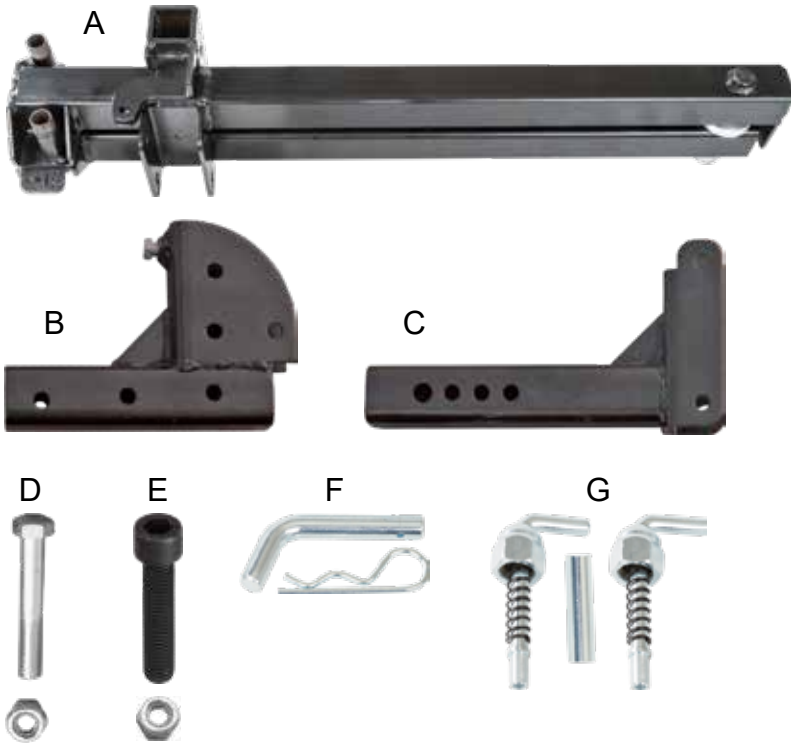

Part	Description	Quantity
A	Swing Away Arm Unit	1
B	Carrier Adapter	1
C	Hitch Adapter	1
D	M12x90 Bolt and Nut	4
E	M16x60 Hitch Tube Bolt and Nut	1
F	Pin and Clip	1
G	Latch Handle Assembly	1

Tools Required

- 17mm wrench
- 19mm wrench
- 10mm hex key

Pre-Assembly

Before assembling the Swing Away, install the Pin and Clip (F) and Latch Handle Assembly (G). This will prevent any unnecessary swinging from occurring.

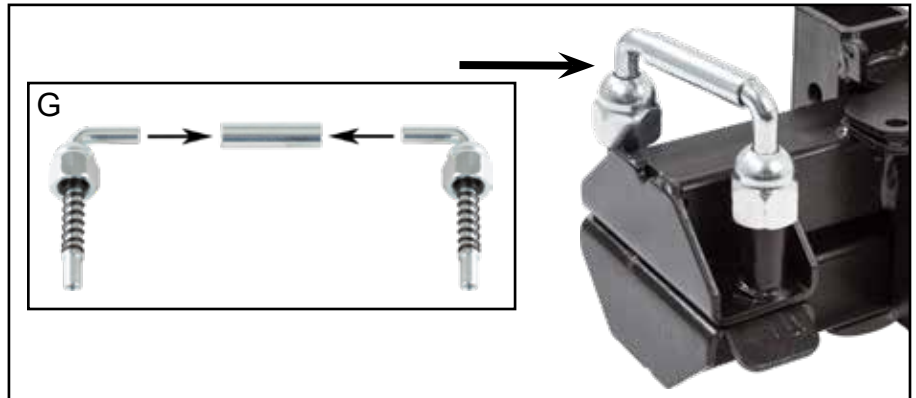
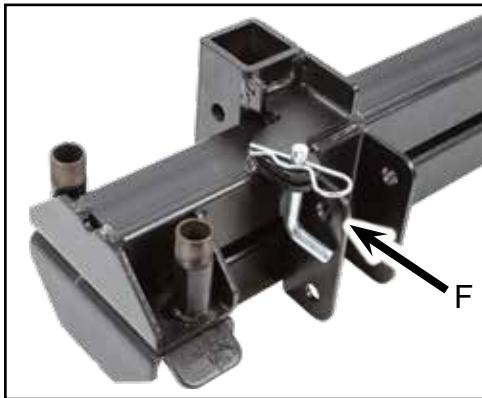

Assembly

The Swing Away system can be added to 2" square hitches only, allowing access to the rear of a vehicle. Do not use with 1-1/4" hitches or hitch adapters. Any attached carrier must remain unloaded during operation.

The Swing Away enables up to a 7" rise configuration. Align the Hitch Adapter (C) upright or downward, depending on the rise desired.

Proper installation requires the use of an anti-tilt bracket (included with mobility carrier) or a pinch bolt to further stabilize the carrier when connected to the Swing Away.



Anti-Tilt Bracket

Slide the anti-tilt bracket (included with mobility carrier) over the Hitch Adapter (C), then lock the Hitch Adapter in the hitch receiver tube with a pinch bolt or hitch pin. Tighten the anti-tilt bracket with a 17mm wrench to provide proper stability.

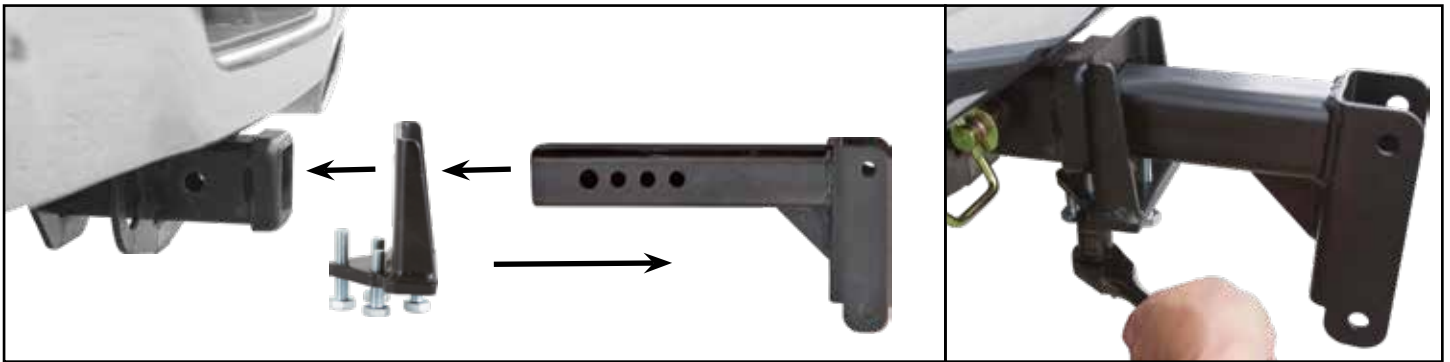

Pinch Bolt

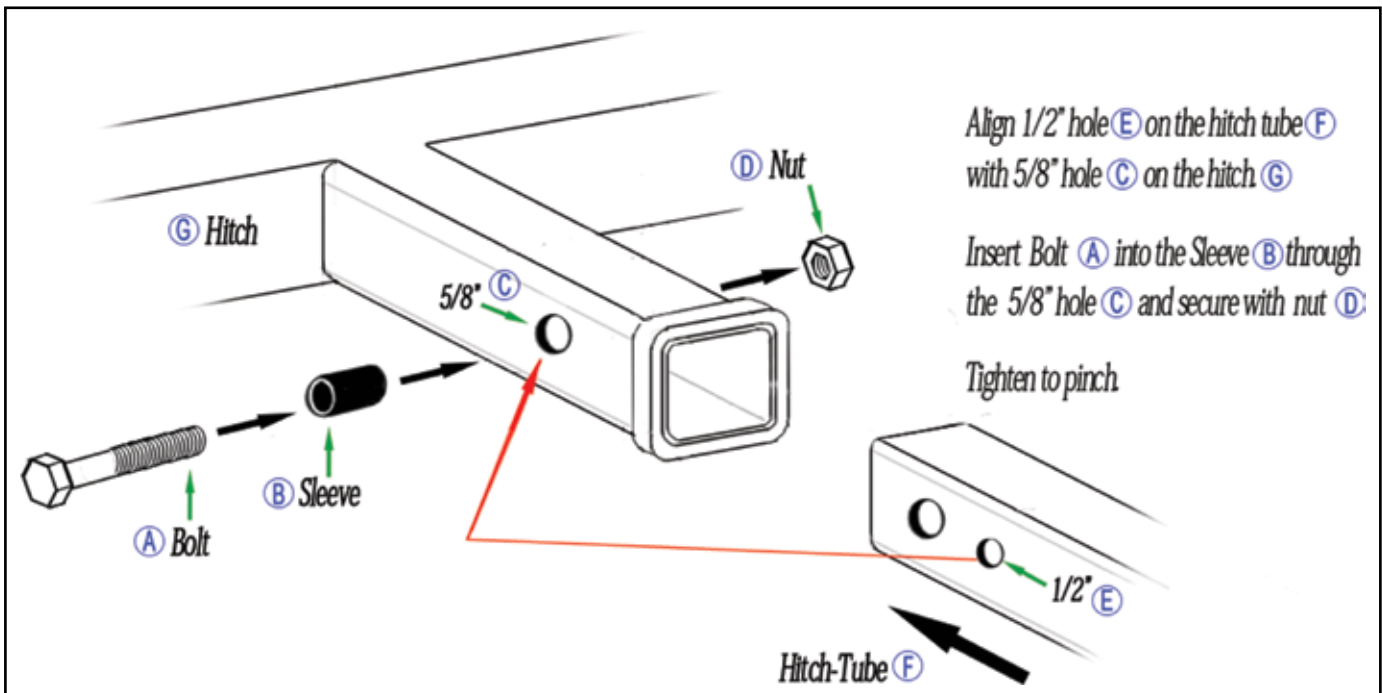

Swing Arm Installation

Note: The anti-tilt bracket pictured in these examples may be replaced with a pinch bolt.

Step 1. Align the Swing Arm (A) with the Hitch Bracket (C).



Step 2. Bolt in place using two nuts and bolts (D). Secure with a 19mm wrench.



Step 3. Align the Carrier Adapter (B) with the Swing Arm (A).



Step 4. Bolt in place at the desired drop with two nuts and bolts (D). Secure with a 19mm wrench.



Assembly to Carrier

Step 1. Remove the pin from the existing hitch tube adapter on the carrier and remove the hitch tube adapter.



Step 2. Slide the carrier into the carrier bracket and lock in place with a lock pin.



Step 3. Tighten the underside bolt to stabilize the carrier connection.

Step 4. To fold the carrier up, remove the lock pin, fold the carrier upright, and insert the locking pin to hold it in place.

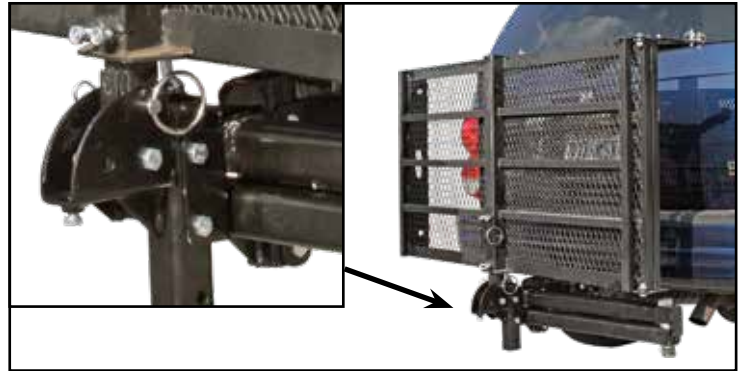

Operation

Step 1. Remove the safety pin.



Step 2. Pull the latch handle upward.

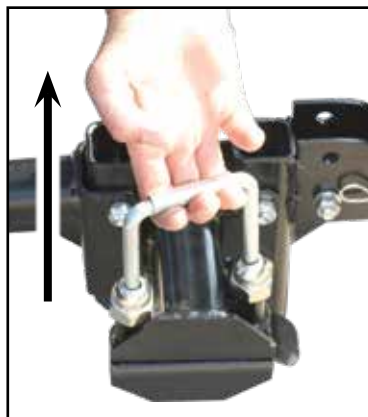

Step 3. Swing away.

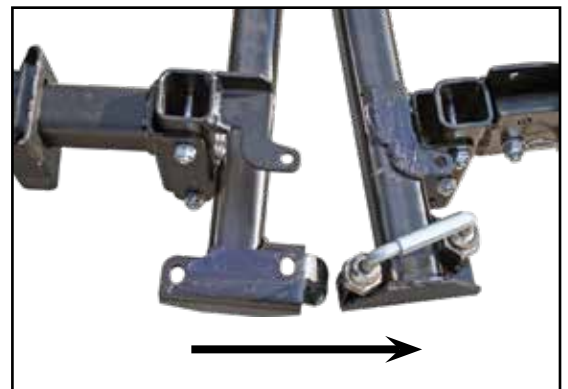

Caution: Do not operate the Swing Away with a loaded carrier.

The Swing Away unit features a safety stop mechanism to help prevent over-swinging the carrier. Take proper precautions to ensure absolute safety while operating. Be sure there are no obstructions preventing the Swing Away system from operating properly.

Product Warranty and Liability

GENERAL PRODUCT WARRANTY: Products purchased from the Authorized Dealer (original place of purchase) or Merchant (“Dealer”) will be free of defects in material and workmanship at the time of receipt, and will meet the specifications stated at the place of purchase transaction or online at the Dealer’s website, under normal use and service when correctly installed, operated and maintained. This product warranty is effective for the period of time stated below, unless otherwise stated in the product instructions or depicted in the product advertisement. **All Authorized Dealer warranties are NON-TRANSFERABLE** and cover only the original end purchaser. This limited warranty does not cover products purchased through non-authorized dealers. Non-authorized dealer receipts are not accepted for warranty verification.

*****Warranty claims must be made directly to the original place of purchase.*****

WARRANTY PERIOD: This warranty remains in force for one year from the date of the product’s accepted delivery. The Authorized Dealer offers a one year manufacturer’s warranty for most products unless otherwise specified on the product advertisement.

WARRANTY SERVICE: The Authorized Dealer will replace any defective or malfunctioning part at no charge, including payment of the shipping costs of parts or replacement product to and from the manufacturer. The purchaser is responsible for labor charges. If the product does not meet specifications as depicted in the advertisement, the Authorized Dealer will refund the full purchase price of the product.

Questions regarding the warranty on a specific product and warranty claims should be directed to the Authorized Dealer with whom the purchase transaction was made.

WARRANTY LIMITATIONS: The above warranty does not apply to products that are repaired, modified or altered by any party other than the Authorized Dealer; are subjected to unusual physical stress or conditions (such as overloaded ramps or corrosion), natural disaster, governmental actions, wars, strikes, labor disputes, riots, theft, vandalism, terrorism or any reason beyond reasonable control; are damaged due to improper installation, misuse, abuse, accident or negligence in use, storage, transportation or handling, or tampering; or to products that are considered consumable items or items requiring repair or replacement due to normal wear and tear.

Product should be inspected prior to signing for delivery. Product damage incurred during shipping, unless noted on the Bill of Lading at the time of delivery, renders this warranty void.

LIMITED LIABILITY: In no event shall THE AUTHORIZED DEALER be liable to the purchaser or any third party for any indirect, incidental, consequential, special, exemplary or punitive damages arising out of the use of the product, including, without limitation, property damage, loss of value of the product or any third party products that are used in or with the product, or loss of use of the product or any third party products that are used in or with the product.

